



Catalogue
CATERING
Chapter
COOKING

Model
FE-8 380-415V 3N 1C

19004728

11/01/2019

ELECTRIC DEEP FAT FRYER, FE-8

Made in stainless steel

Capacity: one 8 litre oil/well. Equipped with 1 basket.

Removable shielded heating elements in stainless steel.

Pilot light for heating.

Control by thermostat (60 °C to 195 °C).

Safety thermostat. Safety switch for assembly.

DIMENSIONS

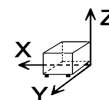

X Width	335 mm	X Gross width	430 mm
Y Depth	485 mm	Y Gross depth	550 mm
Z Height	270 mm	Z Gross height	360 mm
Net Weight	13,0 kg	Gross Weight	15,0 kg
Net volume	0,044 m3	Gross volume	0,085 m3

ELECTRICITY TECHNICAL SPECIFICATIONS

Electric power	6,000 kW
Voltage	380-415V - 3N
Amperage	20A
Electric frequency	50/60Hz



Catalogue
CATERING

Chapter
COOKING

Model
FE-8 380-415V 3N 1C

19004728

11/01/2019

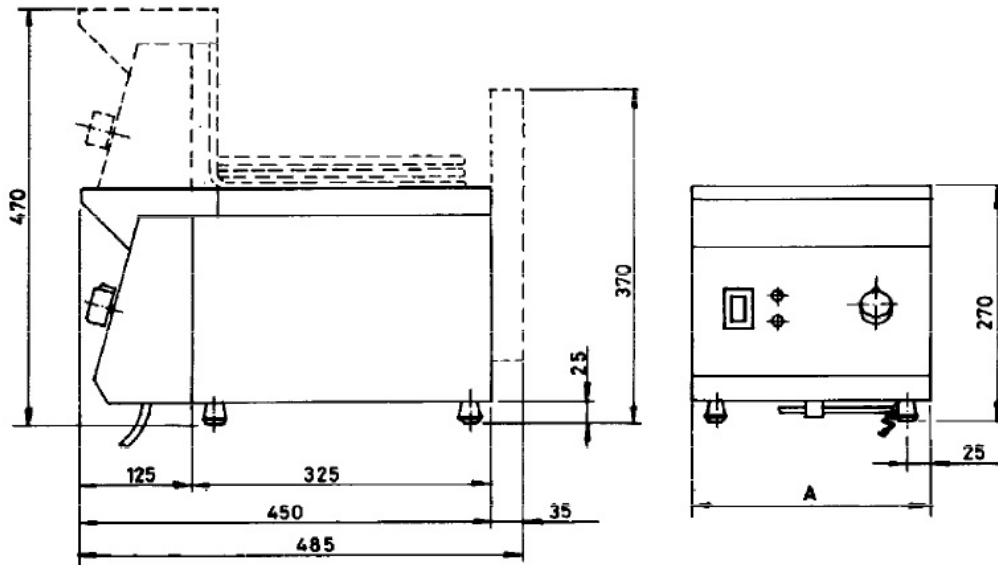

	A
FE-4	175
FE-6	265
FE-8	335